

6' Windsack Specification Sheet

Product Image

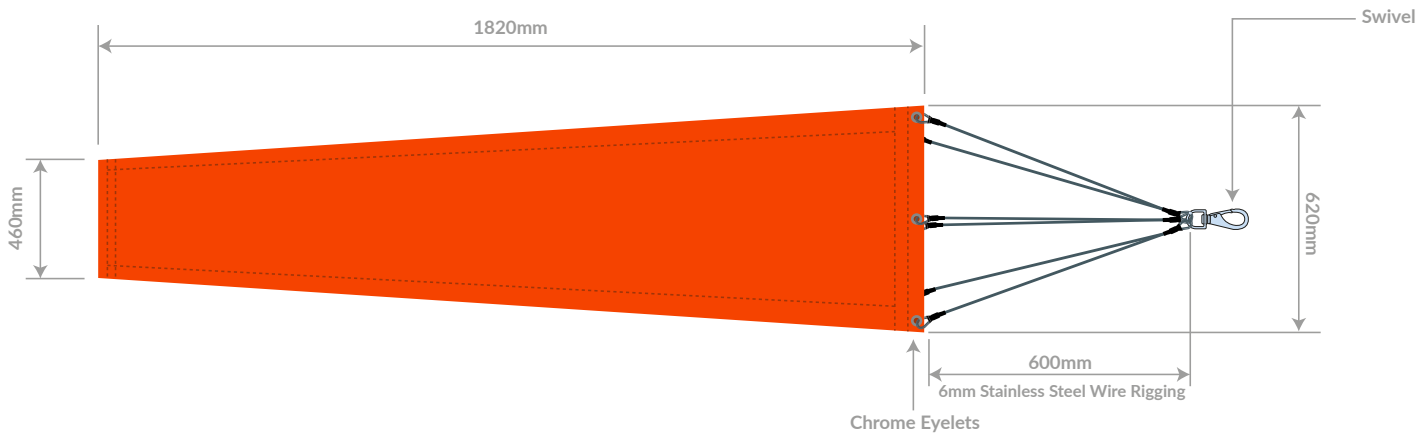

Product Dimensions



Material Specifications



| | |
|--------------------------|--|
| Weight: | 150 gm Polyurethane Coated Polyester. Water Repellent Finish; Clear coating |
| Colour: | Flourescent (Dayglo) Orange |
| Colorfast: | ISO 105 Grade 5.5 |
| Durability: | ISO 7845 50,000 flexes |
| Tensile Strength: | BS 3424 Warp 800 N Weft 500 N |
| Tear Strength: | Warp 40 N Weft 40 N |
| Construction: | 4 Panels : Double fold sewn seams. Nylon Hoop & stainless steel ferrule with integral sleeve. Reinforced mouth with nickel plated brass grommets. Harness 6 arms 6mm stainless steel wire with stainless steel snap swivel Steel thimbles and Copper ferrules |